

# Silicon Carbide Schottky Diode

650 V, 10 A

## FFSH1065B-F085

### Description

Silicon Carbide (SiC) Schottky Diodes use a completely new technology that provides superior switching performance and higher reliability compared to Silicon. No reverse recovery current, temperature independent switching characteristics, and excellent thermal performance sets Silicon Carbide as the next generation of power semiconductor. System benefits include highest efficiency, faster operating frequency, increased power density, reduced EMI, and reduced system size & cost.

### Features

- Max Junction Temperature 175°C
- Avalanche Rated 51 mJ
- High Surge Current Capacity
- Positive Temperature Coefficient
- Ease of Paralleling
- No Reverse Recovery/No Forward Recovery
- AEC-Q101 Qualified
- These Devices are Pb-Free, Halogen Free/BFR Free and are RoHS Compliant

### Applications

- Automotive HEV-EV Onboard Chargers
- Automotive HEV-EV DC-DC Converters



ON Semiconductor®

[www.onsemi.com](http://www.onsemi.com)

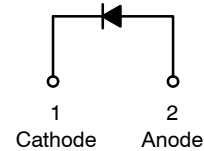

Schottky Diode

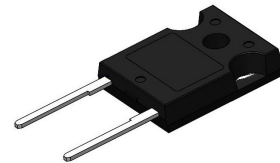

TO-247-2LD  
CASE 340DA

### MARKING DIAGRAM

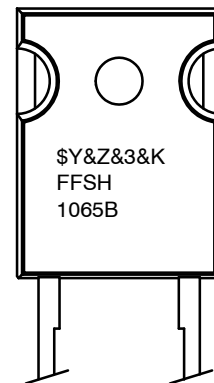

\$Y = ON Semiconductor Logo  
&Z = Assembly Plant Code  
&3 = Numeric Date Code  
&K = Lot Code  
FFSH1065B = Specific Device Code

### ORDERING INFORMATION

See detailed ordering and shipping information on page 2 of this data sheet.

# FFSH1065B-F085

## ABSOLUTE MAXIMUM RATINGS (T<sub>C</sub> = 25°C unless otherwise noted)

Symbol	Parameter	Value	Unit	
V <sub>RRM</sub>	Peak Repetitive Reverse Voltage	650	V	
E <sub>AS</sub>	Single Pulse Avalanche Energy (Note 1)	51	mJ	
I <sub>F</sub>	Continuous Rectified Forward Current @ T <sub>C</sub> < 142°C	10	A	
	Continuous Rectified Forward Current @ T <sub>C</sub> < 135°C	11.5		
I <sub>F, Max</sub>	Non-Repetitive Peak Forward Surge Current	T <sub>C</sub> = 25°C, 10 μs	600	A
		T <sub>C</sub> = 150°C, 10 μs	535	A
I <sub>F, SM</sub>	Non-Repetitive Forward Surge Current T <sub>C</sub> = 25°C	Half-Sine Pulse, t <sub>p</sub> = 8.3 ms	42	A
P <sub>tot</sub>	Power Dissipation	T <sub>C</sub> = 25°C	83	W
		T <sub>C</sub> = 150°C	14	W
T <sub>J</sub> , T <sub>STG</sub>	Operating and Storage Temperature Range	-55 to +175	°C	
	TO247 Mounting Torque, M3 Screw	60	Ncm	

Stresses exceeding those listed in the Maximum Ratings table may damage the device. If any of these limits are exceeded, device functionality should not be assumed, damage may occur and reliability may be affected.

1. E<sub>AS</sub> of 51 mJ is based on starting T<sub>J</sub> = 25°C, L = 0.5 mH, I<sub>AS</sub> = 14.5 A, V = 50 V.

## THERMAL CHARACTERISTICS

Symbol	Parameter	Value	Unit
R <sub>θJC</sub>	Thermal Resistance, Junction to Case, Max	1.81	°C/W

## ELECTRICAL CHARACTERISTICS (T<sub>C</sub> = 25°C unless otherwise noted)

Symbol	Parameter	Test Condition	Min	Typ	Max	Unit
V <sub>F</sub>	Forward Voltage	I <sub>F</sub> = 10 A, T <sub>C</sub> = 25°C	-	1.5	1.7	V
		I <sub>F</sub> = 10 A, T <sub>C</sub> = 125°C	-	1.7	2.0	
		I <sub>F</sub> = 10 A, T <sub>C</sub> = 175°C	-	2	2.4	
I <sub>R</sub>	Reverse Current	V <sub>R</sub> = 650 V, T <sub>C</sub> = 25°C	-	0.5	40	μA
		V <sub>R</sub> = 650 V, T <sub>C</sub> = 125°C	-	1	80	
		V <sub>R</sub> = 650 V, T <sub>C</sub> = 175°C	-	2	160	
Q <sub>C</sub>	Total Capacitive Charge	V = 400 V	-	25	-	nC
C	Total Capacitance	V <sub>R</sub> = 1 V, f = 100 kHz	-	421	-	pF
		V <sub>R</sub> = 200 V, f = 100 kHz	-	40	-	
		V <sub>R</sub> = 400 V, f = 100 kHz	-	34	-	

Product parametric performance is indicated in the Electrical Characteristics for the listed test conditions, unless otherwise noted. Product performance may not be indicated by the Electrical Characteristics if operated under different conditions.

## PACKAGE MARKING AND ORDERING INFORMATION

Part Number	Top Marking	Package	Shipping
FFSH1065B-F085	FFSH1065B	TO-247-2LD (Pb-Free / Halogen Free)	30 Units / Tube

TYPICAL CHARACTERISTICS

( $T_J = 25^\circ\text{C}$  unless otherwise noted)

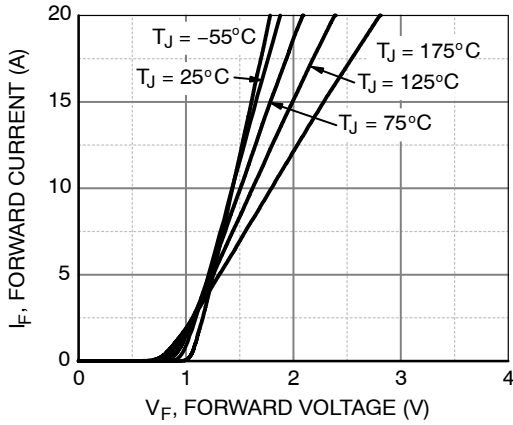

Figure 1. Forward Characteristics

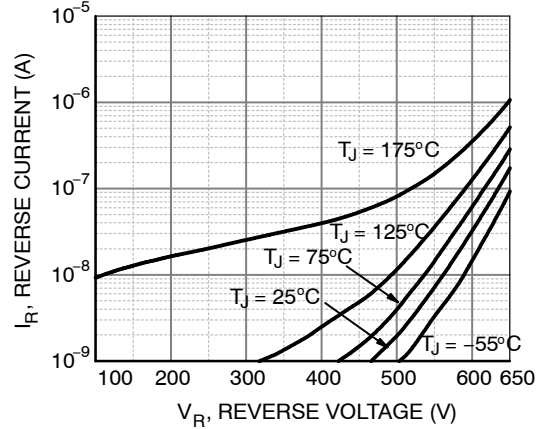

Figure 2. Reverse Characteristics

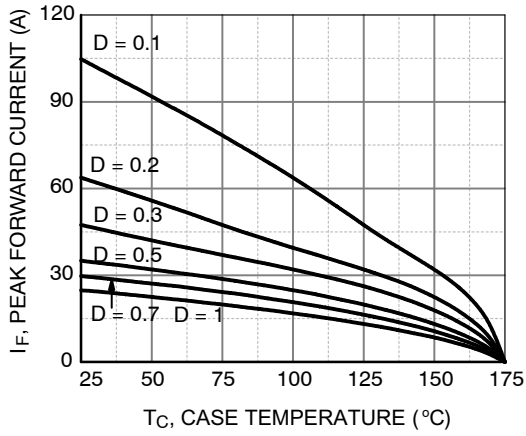

Figure 3. Current Derating

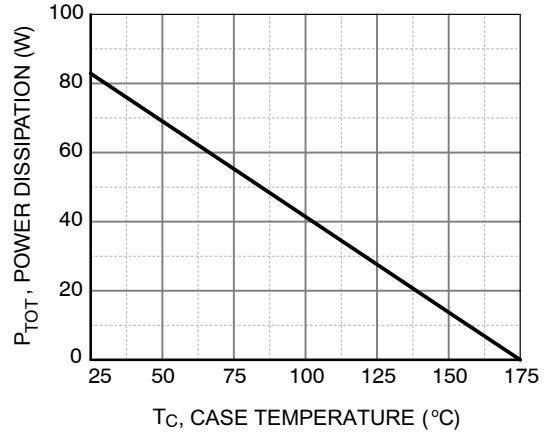

Figure 4. Power Derating

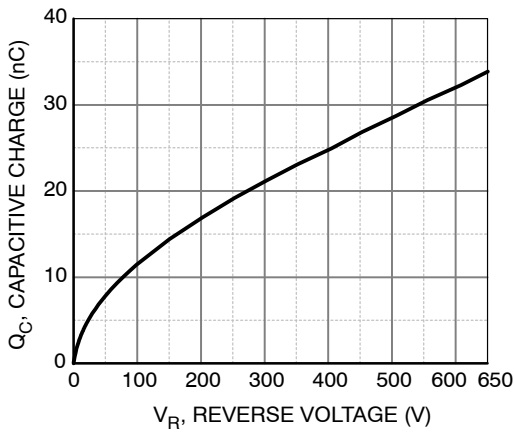

Figure 5. Capacitive Charge vs. Reverse Voltage

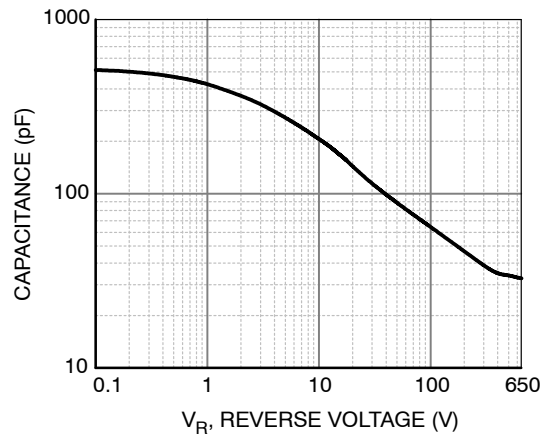

Figure 6. Capacitance vs. Reverse Voltage

# FFSH1065B-F085

## TYPICAL CHARACTERISTICS

( $T_J = 25^\circ\text{C}$  unless otherwise noted)

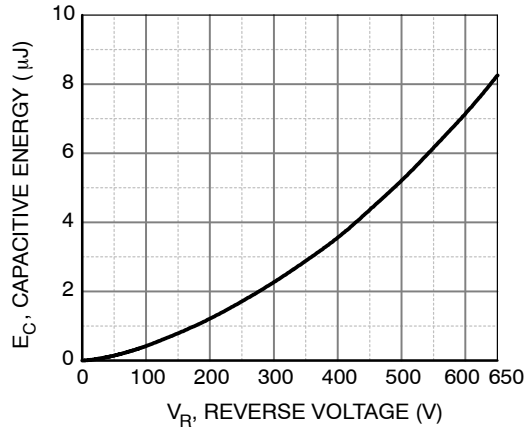

Figure 7. Capacitance Stored Energy

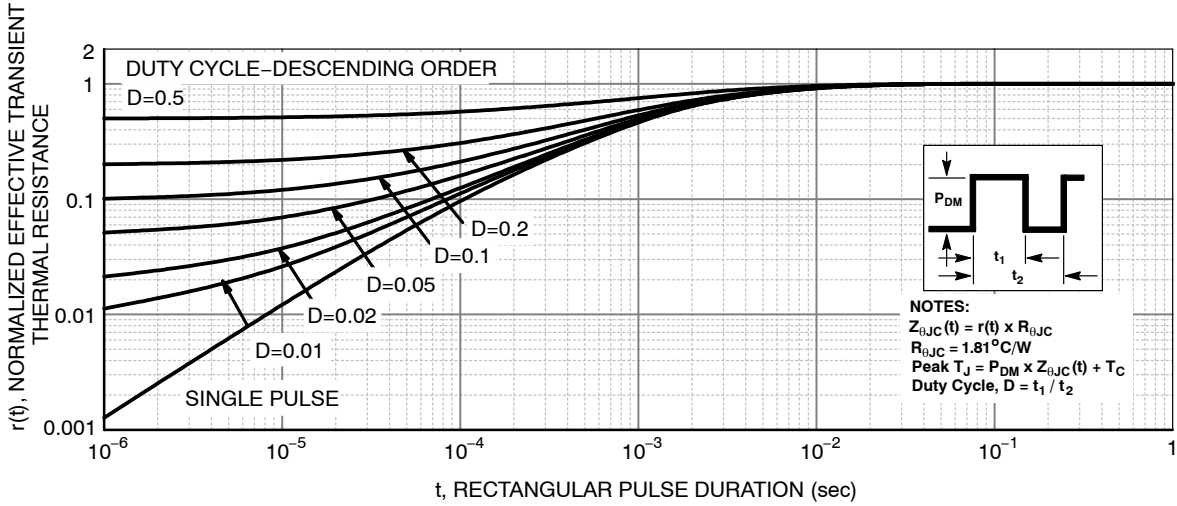

Figure 8. Junction-to-Case Transient Thermal Response Curve

## TEST CIRCUIT AND WAVEFORMS

$L = 0.5 \text{ mH}$   
 $R < 0.1 \Omega$   
 $V_{DD} = 50 \text{ V}$   
 $E_{AVL} = 1/2LI^2 [V_{R(AVL)} / (V_{R(AVL)} - V_{DD})]$   
 $Q1 = \text{IGBT} (BV_{CES} > \text{DUT } V_{R(AVL)})$

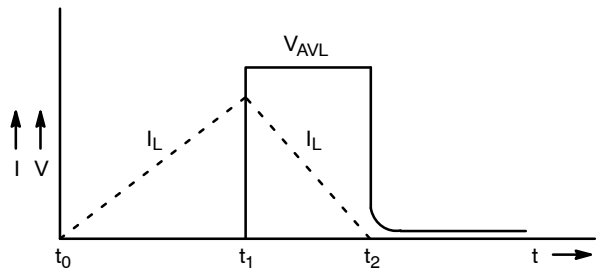
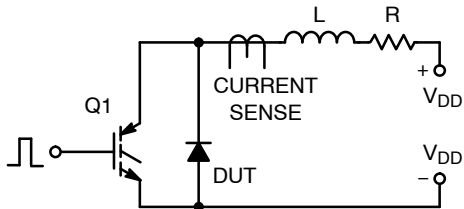

Figure 9. Unclamped Inductive Switching Test Circuit & Waveform

# MECHANICAL CASE OUTLINE

## PACKAGE DIMENSIONS

ON Semiconductor®



### TO-247-2LD CASE 340DA ISSUE A

DATE 27 FEB 2019

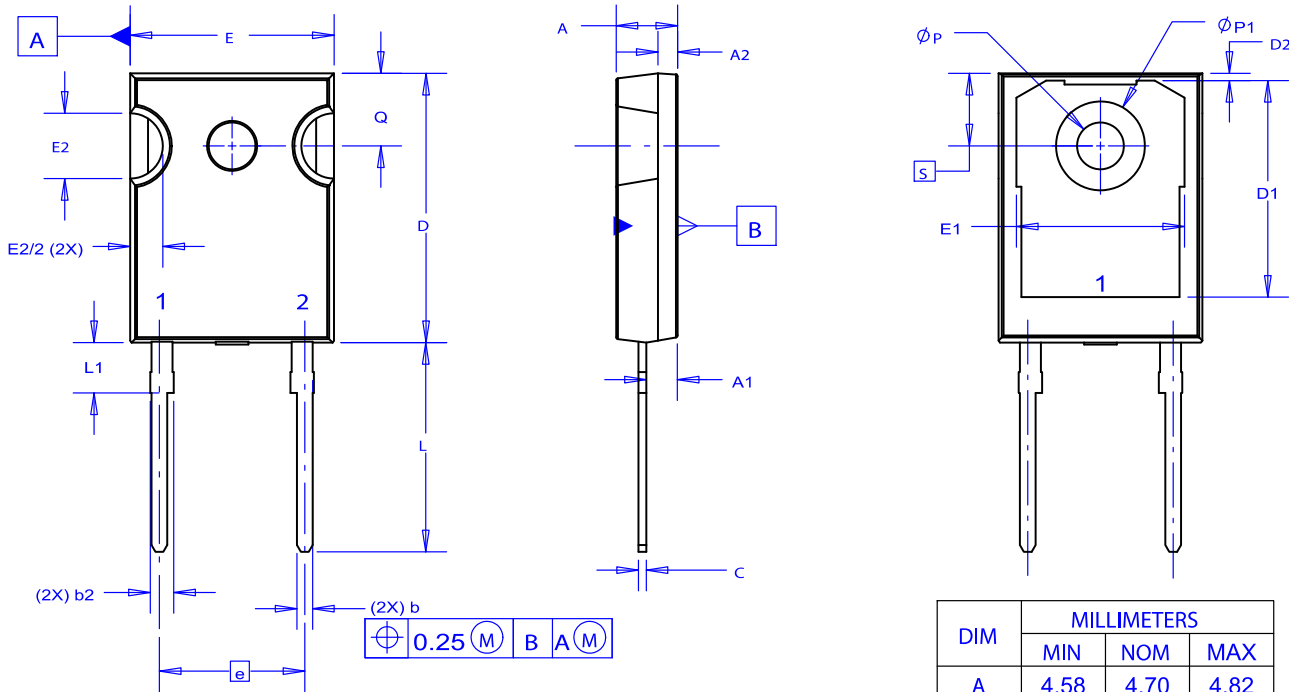

NOTES: UNLESS OTHERWISE SPECIFIED.

- A. DIMENSIONS ARE EXCLUSIVE OF BURRS, MOLD FLASH, AND TIE BAR EXTRUSIONS.
- B. ALL DIMENSIONS ARE IN MILLIMETERS.
- C. DRAWING CONFORMS TO ASME Y14.5 - 2009.
- D. DIMENSION A1 TO BE MEASURED IN THE REGION DEFINED BY L1.
- E. LEAD FINISH IS UNCONTROLLED IN THE REGION DEFINED BY L1.

DIM	MILLIMETERS		
	MIN	NOM	MAX
A	4.58	4.70	4.82
A1	2.20	2.40	2.60
A2	1.40	1.50	1.60
b	1.17	1.26	1.35
b2	1.53	1.65	1.77
c	0.51	0.61	0.71
D	20.32	20.57	20.82
D1	13.08	~	~
D2	0.51	0.93	1.35
E	15.37	15.62	15.87
E1	12.81	~	~
E2	4.96	5.08	5.20
e	~	11.12	~
L	15.75	16.00	16.25
L1	3.69	3.81	3.93
ØP	3.51	3.58	3.65
ØP1	6.60	6.80	7.00
Q	5.34	5.46	5.58
S	5.34	5.46	5.58

### GENERIC MARKING DIAGRAM\*

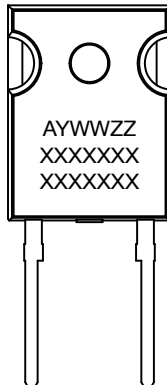

- XXXXX = Specific Device Code
- A = Assembly Location
- Y = Year
- WW = Work Week
- ZZ = Assembly Lot Code

\*This information is generic. Please refer to device data sheet for actual part marking. Pb-Free indicator, "G" or microdot "•", may or may not be present. Some products may not follow the Generic Marking.

<b>DOCUMENT NUMBER:</b>	<b>98AON00714H</b>	Electronic versions are uncontrolled except when accessed directly from the Document Repository. Printed versions are uncontrolled except when stamped "CONTROLLED COPY" in red.
<b>DESCRIPTION:</b>	<b>TO-247-2LD</b>	<b>PAGE 1 OF 1</b>

ON Semiconductor and are trademarks of Semiconductor Components Industries, LLC dba ON Semiconductor or its subsidiaries in the United States and/or other countries. ON Semiconductor reserves the right to make changes without further notice to any products herein. ON Semiconductor makes no warranty, representation or guarantee regarding the suitability of its products for any particular purpose, nor does ON Semiconductor assume any liability arising out of the application or use of any product or circuit, and specifically disclaims any and all liability, including without limitation special, consequential or incidental damages. ON Semiconductor does not convey any license under its patent rights nor the rights of others.

ON Semiconductor and  are trademarks of Semiconductor Components Industries, LLC dba ON Semiconductor or its subsidiaries in the United States and/or other countries. ON Semiconductor owns the rights to a number of patents, trademarks, copyrights, trade secrets, and other intellectual property. A listing of ON Semiconductor's product/patent coverage may be accessed at [www.onsemi.com/site/pdf/Patent-Marking.pdf](http://www.onsemi.com/site/pdf/Patent-Marking.pdf). ON Semiconductor reserves the right to make changes without further notice to any products herein. ON Semiconductor makes no warranty, representation or guarantee regarding the suitability of its products for any particular purpose, nor does ON Semiconductor assume any liability arising out of the application or use of any product or circuit, and specifically disclaims any and all liability, including without limitation special, consequential or incidental damages. Buyer is responsible for its products and applications using ON Semiconductor products, including compliance with all laws, regulations and safety requirements or standards, regardless of any support or applications information provided by ON Semiconductor. "Typical" parameters which may be provided in ON Semiconductor data sheets and/or specifications can and do vary in different applications and actual performance may vary over time. All operating parameters, including "Typicals" must be validated for each customer application by customer's technical experts. ON Semiconductor does not convey any license under its patent rights nor the rights of others. ON Semiconductor products are not designed, intended, or authorized for use as a critical component in life support systems or any FDA Class 3 medical devices or medical devices with a same or similar classification in a foreign jurisdiction or any devices intended for implantation in the human body. Should Buyer purchase or use ON Semiconductor products for any such unintended or unauthorized application, Buyer shall indemnify and hold ON Semiconductor and its officers, employees, subsidiaries, affiliates, and distributors harmless against all claims, costs, damages, and expenses, and reasonable attorney fees arising out of, directly or indirectly, any claim of personal injury or death associated with such unintended or unauthorized use, even if such claim alleges that ON Semiconductor was negligent regarding the design or manufacture of the part. ON Semiconductor is an Equal Opportunity/Affirmative Action Employer. This literature is subject to all applicable copyright laws and is not for resale in any manner.

## PUBLICATION ORDERING INFORMATION

### LITERATURE FULFILLMENT:

Email Requests to: [orderlit@onsemi.com](mailto:orderlit@onsemi.com)

ON Semiconductor Website: [www.onsemi.com](http://www.onsemi.com)

### TECHNICAL SUPPORT

North American Technical Support:  
Voice Mail: 1 800-282-9855 Toll Free USA/Canada  
Phone: 011 421 33 790 2910

### Europe, Middle East and Africa Technical Support:

Phone: 00421 33 790 2910

For additional information, please contact your local Sales Representative

# Mouser Electronics

Authorized Distributor

Click to View Pricing, Inventory, Delivery & Lifecycle Information:

[ON Semiconductor:](#)

[FFSH1065B-F085](#)